

LED Intelligent Driver (CV)

- TRIAC/0-10V/1-10V/10V PWM/RESISTANCE DIM
- With soft-on and fade in function, visual more comfortable.
- Dimming range: 0~100%, LED start at 1% possible.
- 0-100% flicker-free, High frequency exemption level.
- High Efficient driver: efficiency 88%, PF>0.95, THD<10%
- Over load / Over temp. / Short circuit / Over voltage protection, recover automatically.
- Suitable for internal lights application for I / II / III.
- Up to 50000-hour life time.



5 in 1 dimming
0-10V
1-10V
10V PWM
TRIAC DIM
Resistance DIM

100-277V Dimming

PF>0.95

THD<10%

Flicker-free
IEEE 1789
High frequency exemption level



CE SELV IP67



Specification

Model	YSD-60WUGF-12TL	YSD-60WUGF-24TL	
OUTPUT	Output voltage	12VDC	24VDC
	Output voltage range	12VDC±0.3VDC	24VDC±0.6VDC
	Output current	Max 5A	Max 2.5A
	Output power	Max 60W	
	Output power range	0~60W	
	With or without strobe	No strobe	
	Dimming range	0~100%, dimming depth: Max. 1%	
	Ripple & Noise	≤200mV	≤400mV
PWM frequency	3500Hz		
INPUT	Dimming interface	TRIAC/0-10V/1-10V/10V PWM/RESISTANCE DIM	
	Input voltage	100-277Vac	
	Frequency	50/60Hz	
	Input current	0.72~0.26A	
	Power factor	PF>0.95/230Vac, at full load	
	THD	≤10% at 230Vac, at full load	
	Efficiency (typ.)	88%	89%
	Inrush current(typ.)	Cold start 30A at 230Vac	
	Control surge capability	L-N:2KV	
	Leakage current	Max. 0.5mA	
ENVIRONMENT	Working temperature	ta: -30°C ~ 50°C tc: 80°C	
	Working humidity	20 ~ 95%RH, non-condensing	
	Storage temp., humidity	-40°C ~ 80°C, 10~95%RH	
	Vibration	10~500Hz, 2G 12min./1cycle, period for 72min. each along X, Y, Z axes.	
PROTECTION	Overtemperature	Protection type: Shut down o/p voltage, re--power on to recover	
	Over voltage protection	Shut down the output when non-load voltage ≥ 13V, re-power on to recover after fault condition is removed.	Shut down the output when non-load voltage ≥ 26V, re-power on to recover after fault condition is removed.
	Over load protection	Shut down the output when current load ≥ 110%, auto recovers.	
	Short circuit protection	Protection type: 1. When the first-level short-circuit protection is triggered, the fault can be automatically recovered; 2. When the second-level short-circuit protection is triggered, the power needs to be turned on again after the fault is eliminated	
SAFETY & EMC	Withstand voltage	I/P-O/P: 3750Vac	
	Isolation resistance	I/P-O/P: 100MΩ/500VDC/25°C/70%RH	
	Safety standards	IEC/EN61347-1, IEC/EN61347-2-13	
	EMC emission	EN55015, EN61000-3-2 Class C, IEC61000-3-3	
	EMC immunity	EN61000-4-2,3,4,5,6,8,11 EN61547	
	Strobe test standard	IEEE 1789	

Dimensions

Unit: mm

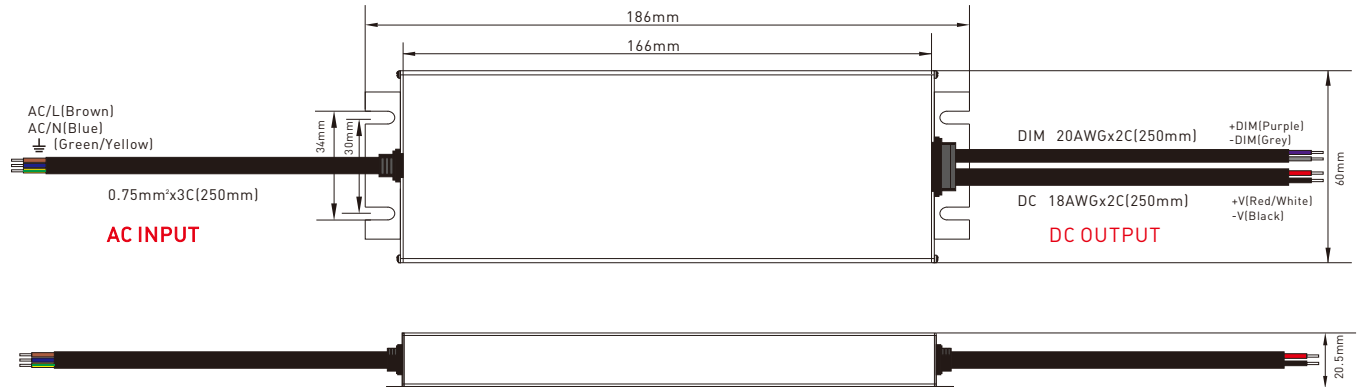

Wiring diagram

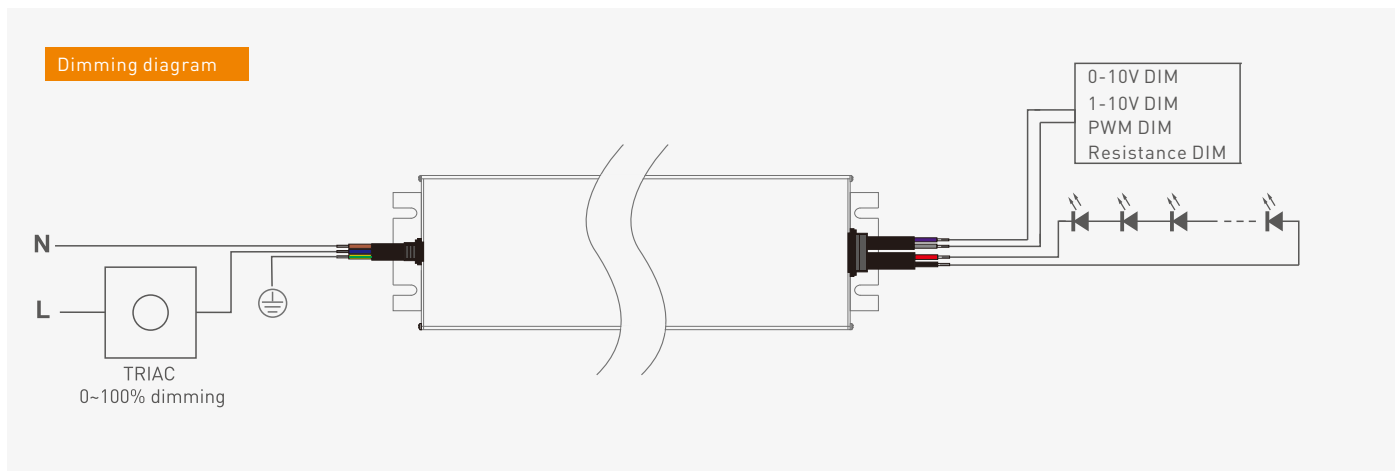

Relationship diagrams

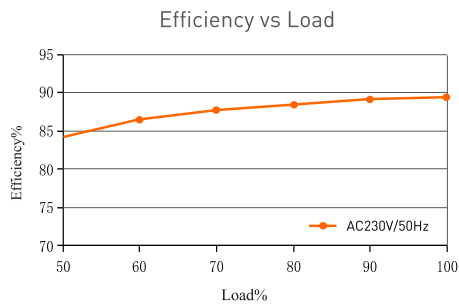

YSD-60WUGF-12TL

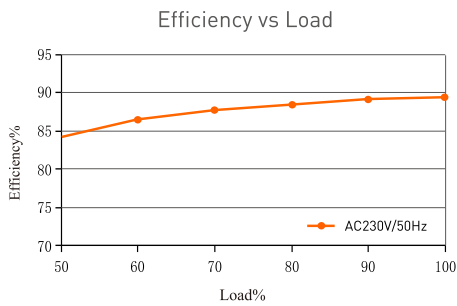

YSD-60WUGF-24TL

Packaging Information

DIMENSION	186x60x20.5mm(LxWxH)
PACKING	219x77x25mm(LxWxH)
CARTON QUANTITY	
CARTON SIZE	
WEIGHT	400g±10g/PCS

Temperature load curve

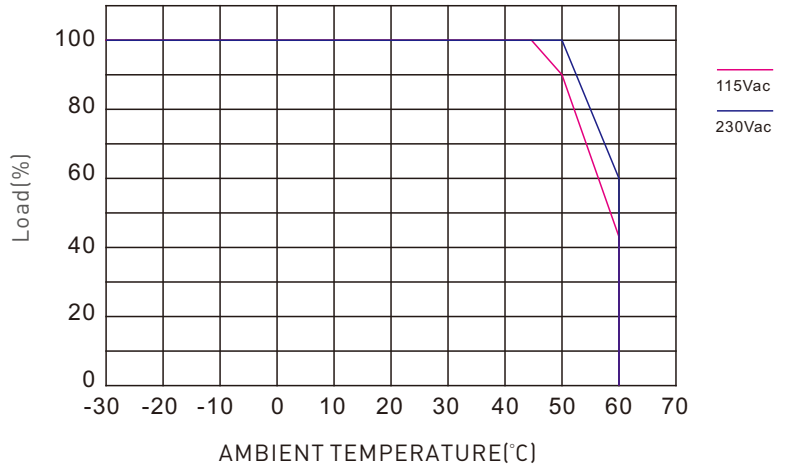

Flicker Test Form

IEEE 1789

Limit of Modulation in low risk area	
Waveform frequency of Optical output	limit (%)
$f \leq 8\text{Hz}$	0.2
$8\text{Hz} < f \leq 90\text{Hz}$	$0.025 \times f$
$90\text{Hz} < f \leq 1250\text{Hz}$	$0.08 \times f$
$f > 1250\text{Hz}$	Exemption assessment
Limit of Modulation in no effect area	
Waveform frequency of Optical output	limit (%)
$f \leq 10\text{Hz}$	0.1
$10\text{Hz} < f \leq 90\text{Hz}$	$0.01 \times f$
$90\text{Hz} < f \leq 3125\text{Hz}$	$[0.08/2.5] \times f$
$f > 3125\text{Hz}$	Exemption assessment (High frequency exemption)

Brightness

- ◆ 1%
- ▲ 5%
- ◆ 10%
- 20%
- ▲ 30%
- 40%
- ★ 50%
- 60%
- 70%
- 80%
- ★ 90%
- ◆ 100%

Exemption assessment
(High frequency exemption)

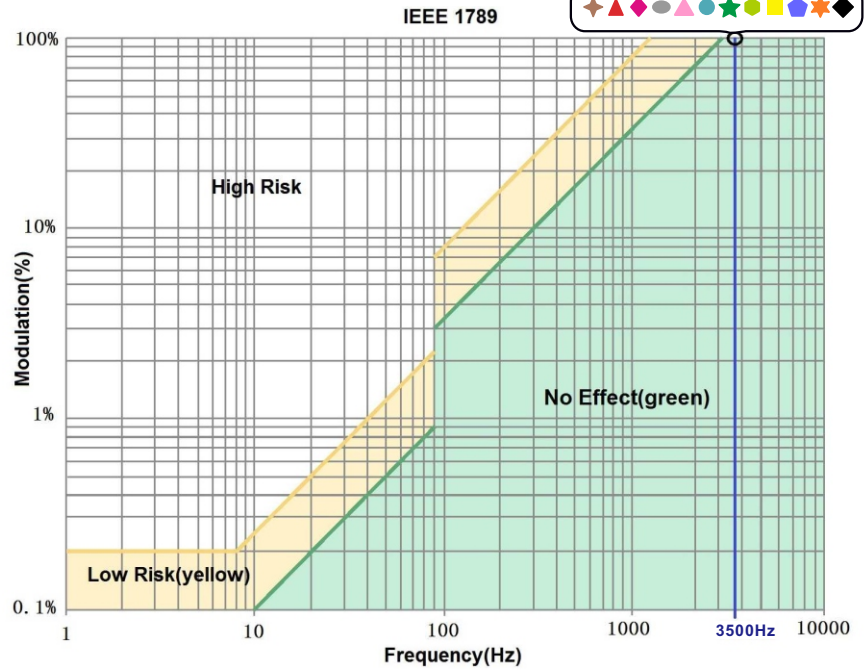

5 in 1 dimming
0-10V
1-10V
10V PWM
TRIAC DIM
Resistance DIM

100-277V Dimming

PF>0.95

THD<10%

LED 智能调光驱动器 (恒压型)

- 可控硅/0-10V/1-10V/10V PWM/电阻 DIM
- 带软启动渐亮功能, 让人眼视觉更舒适.
- 调光范围: 0~100%, LED 从 1% 开始调光.
- 0-100% 全程无频闪, 高频豁免考核级别.
- 高效能电源: 效率 88%, PF>0.95, THD<10%.
- 过载、过温、短路、过压保护.
- 适合室内 I / II / III 类灯具使用.
- 高达50000小时的额定寿命.



无频闪

IEEE 1789

高频豁免考核级别



CE SELV IP67



技术参数

型号	YSD-60WUGF-12TL		YSD-60WUGF-24TL	
输出	输出电压	12VDC	24VDC	
	输出电压范围	12VDC±0.3VDC	24VDC±0.6VDC	
	输出电流	Max 5A	Max 2.5A	
	输出功率	Max 60W		
	输出功率范围	0~60W		
	是否频闪	无频闪		
	调光范围	0~100%, 调光深度: 1%		
	纹波和噪音	≤200mV	≤400mV	
	PWM 调光频率	3500Hz		
输入	调光接口	TRIAC/0-10V/1-10V/10V PWM/电阻 DIM		
	输入电压	100-277Vac		
	频率范围	50/60Hz		
	输入电流	0.72~0.26A		
	功率因素	PF>0.95/230Vac, 满载		
	谐波THD	≤10% at 230Vac, 满载		
	效率(typ.)	88%	89%	
	浪涌电流(typ.)	冷启动30A at 230Vac		
	抗浪涌	L-N:2KV		
漏电流	Max. 0.5mA			
环境	工作温度	ta: -30°C ~ 50°C tc: 80°C		
	工作湿度	20 ~ 95%RH, 无冷凝		
	储存温度 湿度	-40°C ~ 80°C, 10~95%RH		
	耐振动	10~500Hz, 2G 12分钟/周期, X, Y, Z轴各72分钟.		
保护	过温保护	保护类型:关闭输出电压,重新通电恢复		
	过压保护	空载电压≥13V,关闭输出,异常排除后上电恢复	空载电压≥26V, 关闭输出,异常排除后上电恢复	
	过载保护	负载电流 ≥110%,关闭输出,可自动恢复		
	短路保护	保护类型:1.触发第一级短路保护时, 故障消除后可自动回复; 2.触发第二级短路保护时, 故障消除后需重新通电恢复.		
安规和电磁规格	耐压	输入对输出:3750Vac		
	绝缘阻抗	输入对输出:100MΩ/500VDC/25°C/70%RH		
	安全规范	IEC/EN61347-1, IEC/EN61347-2-13		
	电磁兼容发射	EN55015, EN61000-3-2 Class C, IEC61000-3-3		
	电磁兼容抗扰度	EN61000-4-2,3,4,5,6,8,11 EN61547		
	频闪测试标准	IEEE 1789		

尺寸图

单位:mm

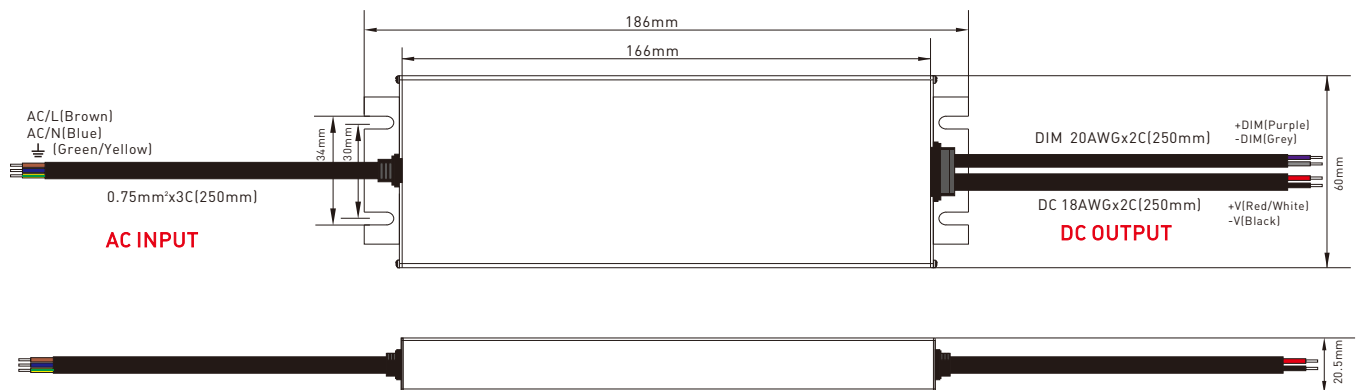

连接应用图

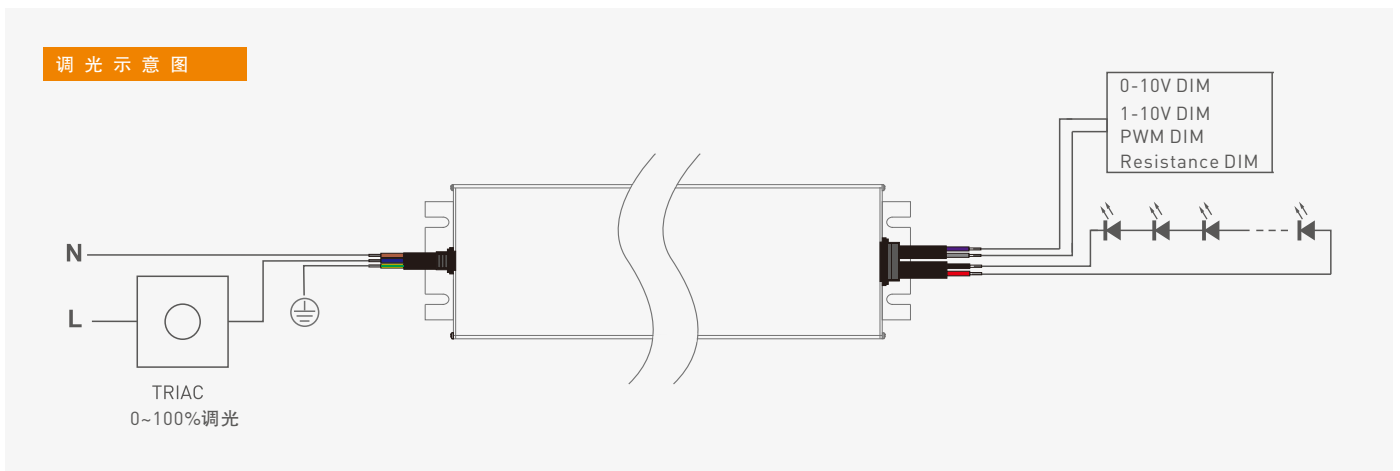

关系图表

效率与负载关系图表

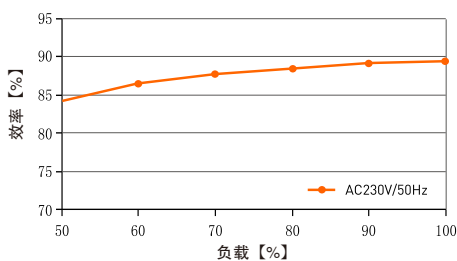

YSD-60WUGF-12TL

效率与负载关系图表

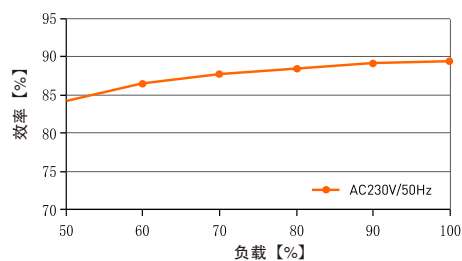

YSD-60WUGF-24TL

温度负载曲线

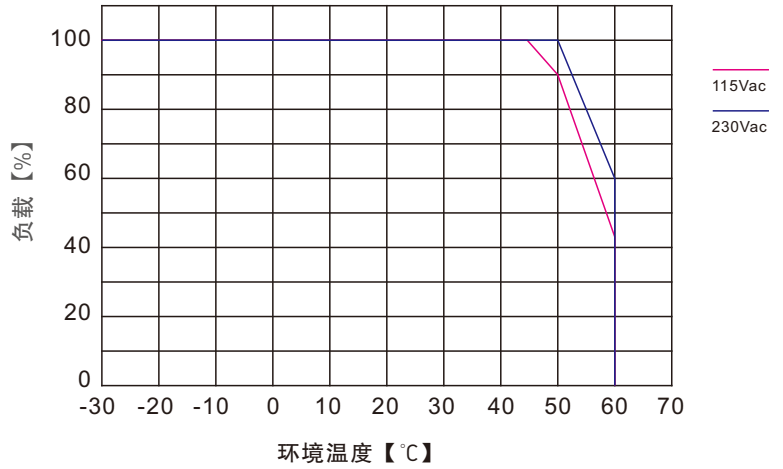

包装信息

产品尺寸	186x60x20.5mm(LxWxH)
包装尺寸	219x77x25mm(LxWxH)
装箱数量	
外箱尺寸	
产品重量	400g±10g/PCS

频闪测试表

IEEE 1789	
低风险区域(Low Risk)的波动深度(Modulation)限值	
光输出波形频率 f	限值[%]
$f \leq 8\text{Hz}$	0.2
$8\text{Hz} < f \leq 90\text{Hz}$	$0.025 \times f$
$90\text{Hz} < f \leq 1250\text{Hz}$	$0.08 \times f$
$f > 1250\text{Hz}$	免除考核
无风险区域(No Effect)的波动深度(Modulation)限值	
光输出波形频率 f	限值[%]
$f \leq 10\text{Hz}$	0.1
$10\text{Hz} < f \leq 90\text{Hz}$	$0.01 \times f$
$90\text{Hz} < f \leq 3125\text{Hz}$	$[0.08/2.5] \times f$
$f > 3125\text{Hz}$	免除考核(高频豁免)

亮度

- ◆ 1%
- ▲ 5%
- ◆ 10%
- 20%
- ▲ 30%
- 40%
- ★ 50%
- 60%
- 70%
- 80%
- ★ 90%
- ◆ 100%

